

1 2 3 4 5 6 7 8

A
B
C
D
E
F

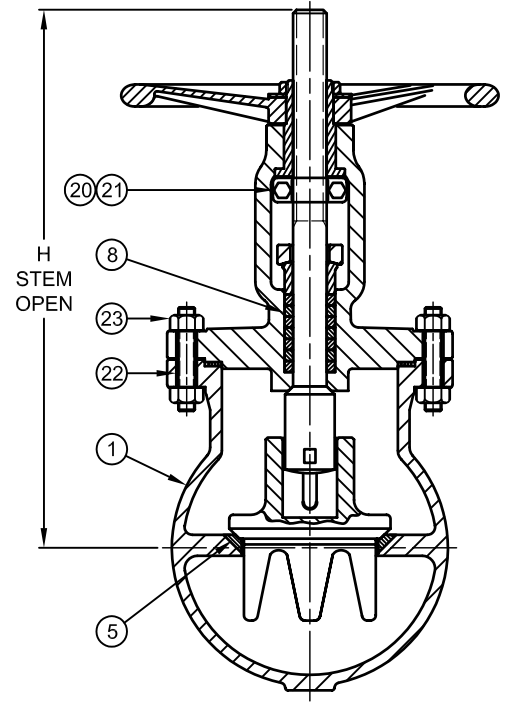
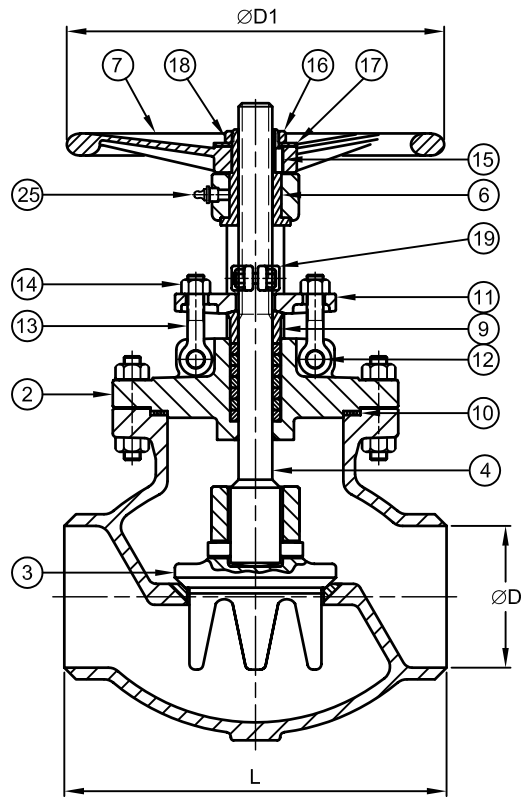

MATERIAL ACCORDING TO ASTM				
NO.	PART NAME	MATERIAL	Q'TY	REMARK
1	BODY	A351-CF3M/CF8M	1	
2	BONNET	A351-CF8M	1	
*	3	DISC	A351-CF8M	1
*	4	STEM ASSEMBLY	A182-F316	1
5	HF OVERLAY	UNS R30006	1	STELLITE
6	STEM NUT	303SS	1	
7	HANDWHEEL	MALLEABLE IRON	1	
*	8	PACKING	TEFLON V-RING	1Set
9	PACKING GLAND	316SS	1	
*	10	GASKET	TFE	1
11	GLAND FLANGE	A351-CF8	1	
12	HINGE PIN	303SS	1	
13	EYEBOLT	A194-B8, CL1	2	
14	EYEBOLT NUT	A193-Gr.8	2	
15	KEY	C.S.	1	
16	STEM NUT LOCK NUT	304SS	1	
17	I.D. PLATE	ALUMINUM	1	
18	SET SCREW	304SS	1	
19	STEM STOP	A351-CF8	1Set	
20	STEM STOP HEX BOLT	A193-B8, CL1	2	
21	STEM STOP HEX NUT	A194-Gr.8	2	
22	BONNET HEX BOLT	A193-B8, CL1	12	
23	BONNET HEX NUT	A194-Gr.8	12	
25	GREASE FITTING	C.S.	1	3/8"

NOTE
 1. SHELL WALL THICKNESS : ASME B16.34
 2. FACE TO FACE DIMENSIONS : ASME B16.10
 3. END DIMENSIONS : ASME B16.25

* RECOMMENDED SPARE PARTS

UNITS: INCHES

SIZE	ØD	ØD1	L	H	SCH.
6"	6.407	13 1/2"	16"	26 3/8"	5

DO NOT SCALE DRAWING		L	LADISH VALVE HOUSTON, TEXAS	
SCALE No Scale			STOP CHECK VALVE CL.150 BUTT WELD, O.S.&Y. B.B. VALVE	
SIZE	A3	DWG NO		
DRAWN	GHB 05/29/07	5236900060A	0	
CHECK	BD 05/29/07			
APPR.	BD 05/29/07			

1 2 3 4 5 6 7 8